

# TOSHIBA



## DVD VIDEO PLAYER

# SD-4000KU

# SD-4000KC

OWNER'S MANUAL



Introduction 2

Connections 19

Function setup 23

Others 29

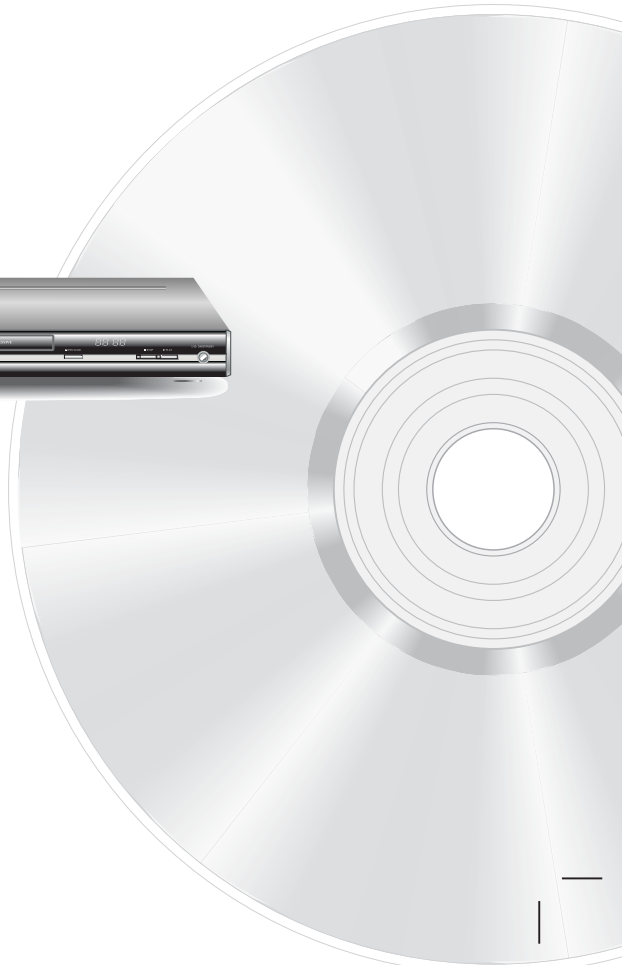

## SAFETY PRECAUTIONS

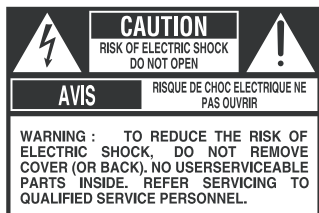

The lightning flash with arrowhead symbol, within an equilateral triangle, is intended to alert the user to the presence of uninsulated "dangerous voltage" within the product's enclosure that may be of sufficient magnitude to constitute a risk of electric shock to persons.



The exclamation point within an equilateral triangle is intended to alert the user to the presence of important operating and maintenance (servicing) instructions in the literature accompanying the appliance.



The symbol for CLASS II (Double Insulation)

**WARNING: TO REDUCE THE RISK OF FIRE OR ELECTRIC SHOCK, DO NOT EXPOSE THIS APPLIANCE TO RAIN OR MOISTURE. DANGEROUS HIGH VOLTAGES ARE PRESENT INSIDE THE ENCLOSURE. DO NOT OPEN THE CABINET. REFER SERVICING TO QUALIFIED PERSONNEL ONLY.**

**CAUTION: TO PREVENT ELECTRIC SHOCK, MATCH WIDE BLADE OF PLUG TO WIDE SLOT, FULLY INSERT.**

**ATTENTION: POUR EVITER LES CHOCES ELECTRIQUES, INTRODUIRE LA LAME LA PLUS LARGE DE LA FICHE DANS LA BORNE CORRESPONDANTE DE LA PRISE ET POUSSER JUSQU'AU FOND.**

**CAUTION: PLEASE READ AND OBSERVE ALL WARNINGS AND INSTRUCTIONS GIVEN IN THIS OWNER'S MANUAL AND THOSE MARKED ON THE UNIT. RETAIN THIS BOOKLET FOR FUTURE REFERENCE.**

## IMPORTANT SAFETY INSTRUCTIONS

1. Read these instructions.
2. Keep these instructions.
3. Heed all warnings.
4. Follow all instructions.
5. Do not use this apparatus near water.
6. Clean only with dry cloth.
7. Do not block any ventilation openings. Install in accordance with the manufacturer's instructions.
8. Do not install near any heat sources such as radiators, heat registers, stoves, or other apparatus (including amplifiers) that produce heat.
9. Do not defeat the safety purpose of the polarized or grounding type plug. A polarized plug has two blades with one wider than the other. A grounding type plug has two blades and a third grounding prong. The wide blade or the third prong are provided for your safety. If the provided plug does not fit into your outlet, consult an electrician for replacement of the obsolete outlet.
10. Protect the power cord from being walked on or pinched particularly at plugs, convenience receptacles, and the point where they exit from the apparatus.
11. Only use attachments/accessories specified by the manufacturer.

## IMPORTANT SAFETY INSTRUCTIONS

12. Use only with the cart, stand, tripod, bracket, or table specified by the manufacturer, or sold with the apparatus. When a cart is used, use caution when moving the cart/apparatus combination to avoid injury from tip over.



Introduction

13. Unplug this apparatus during lightning storms or when unused for long periods of time.
14. Refer all servicing to qualified service personnel. Servicing is required when the apparatus has been damaged in any way, such as power supply cord or plug is damaged, liquid had been spilled or objects have fallen into the apparatus, the apparatus has been exposed to rain or moisture, does not operate normally, or has been dropped.

## ADDITIONAL SAFETY INSTRUCTIONS

15. When you use headphones, keep the volume at a moderate level. If you use the headphones continuously with high volume sound, it may cause hearing damage.
16. Do not overload wall outlets, extension cords, or integral convenience receptacles as this can result in a risk of fire or electric shock.
17. Apparatus shall not be exposed to dripping or splashing and no objects filled with liquids, such as vases, shall be placed on the apparatus.
18. Keep your fingers well clear of the disc tray as it is closing. Neglecting to do so may cause serious personal injury.
19. Do not place a heavy object on or step on the apparatus. The object may fall, causing serious personal injury and serious damage to the apparatus.
20. Do not use a cracked, deformed, or repaired disc. These discs are easily broken and may cause serious personal injury and apparatus malfunction.
21. If the apparatus should smoke or smell, immediately disconnect the power cord from the wall outlet. Wait until the smoke or smell stops, then ask your dealer for a check and repair. Neglecting to do so may cause fire.
22. While it is thundering, do not touch the connecting cables or the apparatus.
23. The apparatus includes lead, an ingredient of solder used on the PCB, which is a harmful substance to human and the environment. When disposing of this apparatus, follow the rules and regulations in your area.

## IMPORTANT SAFETY INSTRUCTIONS

**CAUTION:** This Digital Video Disc Player employs a Laser System. To ensure proper use of this product, please read this owner's manual carefully and retain for future reference. Should the unit require maintenance, contact an authorized service location. Use of control or adjustments or performance of procedures other than those specified herein may result in hazardous radiation exposure. To prevent direct exposure to laser beam, do not try to open the enclosure. Visible and invisible laser radiation when open and interlocks defeated. **DO NOT STARE INTO BEAM.**

**FCC NOTICE:** This equipment has been tested and found to comply with the limits for a Class B digital device, pursuant to part 15 of the FCC Rule. These limits are designed to provide reasonable protection against harmful interference in a residential installation. This equipment generates, uses, and can radiate radio frequency energy and, if not installed and used in accordance with the instructions, may cause harmful interference to radio communications. However, there is no guarantee that interference will not occur in a particular installation. If this equipment does cause harmful interference to radio or television reception, which can be determined by turning the equipment off and on, the user is encouraged to try to correct the interference by one or more of the following measures:

- Reorient or relocate the receiving antenna.
- Increase the separation between the equipment and receiver.
- Connect the equipment into an outlet on a circuit different from that to which the receiver is connected.
- Consult the dealer or an experienced radio/TV technician for help.

Changes or modifications made to this equipment, not expressly approved by Toshiba, or parties authorized by Toshiba, could void the user's authority to operate the equipment.

**CAUTION:** These servicing instruction are for use by qualified service personnel only .To reduce the risk of electric shock do not perform any servicing other than that contained in the operating instructions unless you are qualified to do so.

In the spaces provided below, record the Model and Serial No. located on the rear panel of your DVD Video Player.

**Model No.** \_\_\_\_\_

**Serial No.** \_\_\_\_\_

**Retain this information for future reference.**

Location of the required label

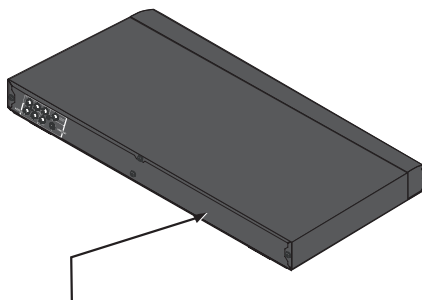

**CERTIFICATION:** PRODUCT COMPLIES WITH DHHS RULE 21 CFR SUBCHAPTER J IN EFFECT AT DATE OF MANUFACTURE.

**Be aware that this equipment is still powered when in standby mode. To disconnect this equipment completely from the mains power, pull out the power plug from the wall outlet.**

# Precautions

## Notes on handling

- When shipping the DVD video player, the original shipping carton and packing materials come in handy. For maximum protection, repack the unit as it was originally packed at the factory. Take care not to give it a shock or shake when carrying.
- Do not use volatile liquids, such as insect spray, near the DVD video player. Do not leave rubber or plastic products in contact with the DVD video player for a long time. They will leave marks on the finish.
- The top and rear panels of the DVD video player may become warm after a long period of use. This is not a malfunction.
- When the DVD video player is not in use, be sure to remove the disc and turn off the power.
- If you do not use the DVD video player for a long period, the unit may not function properly in the future. Turn on and use the DVD video player occasionally.

## Notes on locating

- Place the DVD video player on a level surface with good ventilation. Do not use it on a shaky or unstable surface such as a wobbling table or inclined stand. The loaded disc may come off the proper position and cause damage to the DVD video player.
- When you place this DVD video player near a TV, radio, or VCR, the playback picture may become poor and the sound may be distorted. In this case, place the DVD video player away from the TV, radio, or VCR.

## Notes on cleaning

Use a soft, dry cloth for cleaning.

- For stubborn dirt, soak the cloth in a weak detergent solution, wring well and wipe. Use a dry cloth to wipe it dry.  
Do not use any type of solvent, such as thinner and benzene, as they damage the surface of the DVD video player.
- If you use a chemical saturated cloth to clean the unit, follow that product's instructions.

## Inspection and Maintenance

This DVD video player is a high technology, precision device. If the optical pick up lens and disc drive parts become dirty or worn down, the picture quality may be reduced. To avoid reduction in picture quality, it is recommended that regular inspection and maintenance (cleaning or parts replacement) be performed every 1,000 hours of use. For further details, contact your nearest consumer electronics dealer.

## Notes on moisture condensation

Moisture condensation damages the DVD video player. Please read the following carefully.

Moisture condensation occurs, for example, when you pour a cold drink into a glass on a warm day. Drops of water form on the outside of the glass. In the same way, moisture may condense on the optical pick up lens inside this unit, one of the most crucial internal parts of the DVD video player.

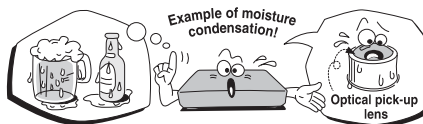

- Moisture condensation occurs during the following cases.
  - When you bring the DVD video player directly from a cold place to a warm place.
  - When you use the DVD video player in a room where you just turned on the heater, or a place where the cold wind from the air conditioner directly hits the unit.
  - In summer, when you use the DVD video player in a hot and humid place just after you move the unit from an air conditioned room.
  - When you use the DVD video player in a humid place.

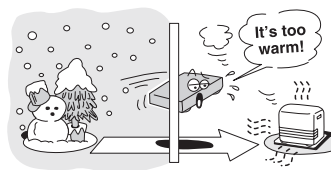

- Do not use the DVD video player when moisture condensation may occur.  
If you use the DVD video player in such a situation, it may damage discs and internal parts. Remove the disc, connect the power cord of the DVD video player to the wall outlet, turn on the DVD video player, and leave it for two or three hours. After two or three hours, the DVD video player will have warmed up and evaporated any moisture. Keep the DVD video player connected to the wall outlet and moisture condensation will seldom occur.

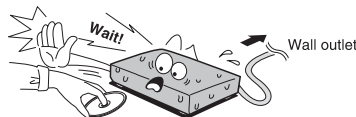

## Notes on Discs

### On handling discs

- Do not touch the playback side of the disc.

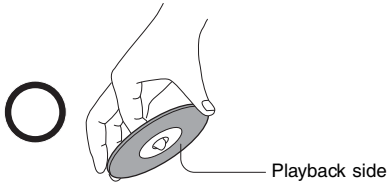

- Do not attach paper or tape to discs.



### On cleaning discs

- Fingerprints and dust on the disc cause picture and sound deterioration. Wipe the disc from the center outwards with a soft cloth. Always keep the disc clean.

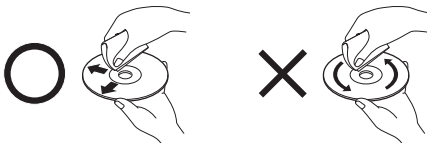

- If you cannot wipe off the dust with a soft cloth, wipe the disc lightly with a slightly moistened soft cloth and finish with a dry cloth.
- Do not use any type of solvent such as thinner, benzene, commercially available cleaners or antistatic spray for vinyl LPs. It may damage the disc.

### On storing discs

- Do not store discs in a place subject to direct sunlight or near heat sources.
- Do not store discs in places subject to moisture and dust such as a bathroom or near a humidifier.
- Store discs vertically in a case. Stacking or placing objects on discs outside of their case may cause warping.

### Notes on copyright

The unauthorized recording, use, distribution, or revision of copyrighted materials including, without limitation, television programs, videotapes, and DVDs, is prohibited under the Copyright Laws of the United States and other countries, and may subject you to civil and criminal liability.

This product incorporates copyright protection technology that is protected by method claims of certain U.S. patents and other intellectual property rights owned by Macrovision Corporation and other rights owners. Use of this copyright protection technology must be authorized by Macrovision Corporation, and is intended for home and other limited viewing uses only unless otherwise authorized by Macrovision Corporation. Reverse engineering or disassembly is prohibited.

### Structure of disc contents

Normally, DVD video discs are divided into titles, and the titles are subdivided into chapters. VIDEO CDs and audio CDs are divided into tracks.

DVD video disc

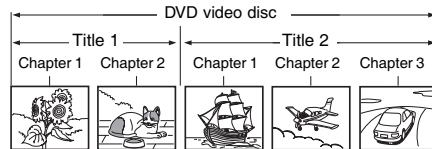

VIDEO CD/audio CD

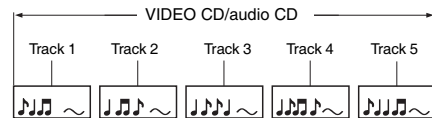

Each title, chapter or track is assigned a number, which is called "title number", "chapter number" or "track number" respectively. There may be discs that do not have these numbers.



# Notes on Discs (continued)

## About this owner's manual

This owner's manual explains the basic instructions of this DVD video player. Some DVD video discs are produced in a manner that allows specific or limited operation during playback. As such, the DVD video player may not respond to all operating commands. This is not a defect in the DVD video player. Refer to instruction notes of discs.

"Ⓢ" may appear on the TV screen during operation. A "Ⓢ" means that the operation is not permitted by the DVD video player or the disc.

### About



The    icons on the heading bar show the playable discs for the function described under that heading.

 : You can use this function with DVD video discs.

 : You can use this function with VIDEO CDs.

 : You can use this function with audio CDs.

## Notes on region numbers

The region number of this DVD video player is 1. If region numbers, which stand for their playable area, are printed on your DVD video disc and you do not find  or , disc playback will not be allowed by the player. (In this case, the DVD video) player will display a message on screen.)

Some DVDs that have no region code label may still be subject to area restrictions and therefore not playable.

## On VIDEO CDs





This DVD video player supports VIDEO CDs equipped with the PBC (Version 2.0) function. (PBC is the abbreviation of Playback Control.)

You can enjoy two playback variations depending on types of discs.

- VIDEO CD not equipped with PBC function (Ver 1.1). Sound and movie can be played on this DVD video player in the same way as an audio CD.
- VIDEO CD equipped with PBC function (Ver 2.0). In addition to operation of a VIDEO CD not equipped with the PBC function, you can enjoy playback of interactive software with search function by using the menu displayed on the TV screen (Menu Playback). Some of the functions described in this owner's manual may not work with some discs.

## Playable discs

This DVD video player can play the following discs.

|                 | Disc Mark   | Contents                        | Disc Size        | Maximum playback time   |
|-----------------|---|---------------------------------|------------------|---|
| DVD video discs |  | Audio + video (moving pictures) | 12 cm            | Approx. 4 hours (single sided disc)<br>Approx. 8 hours (double sided disc)        |
|                 |   |                                 | 8 cm             | Approx. 80 minutes (single sided disc)<br>Approx. 160 minutes (double sided disc) |
| VIDEO CDs       |  | Audio + video (moving pictures) | 12 cm            | Approx. 74 minutes  |
|                 |   |                                 | 8 cm             | Approx. 20 minutes  |
| Audio CDs       |  | Audio                           | 12 cm            | Approx. 74 minutes  |
|                 |   |                                 | 8 cm (CD single) | Approx. 20 minutes  |
| DivX®           |  | Audio + video (moving pictures) | 12 cm            | It depends on DivX® quality   |
|                 |   |                                 | 8 cm             |   |

The following discs are also available.

- DVD±R/±RW, DVD±R DL and DVD ROM discs of DVD video format.
  - CD R/CD RW discs of CD DA, Video CD, SVCD, MP3, WMA, DivX® or JPEG format.
- Some of these discs may be incompatible.

- You cannot play discs other than those listed above.
- You cannot play DVD RAM discs or non-standardized discs, etc., even if they may be labeled as above.
- DVD ROM disc is not supported by DAT files.
- This DVD video player uses the NTSC color system, and cannot play DVD video discs recorded in any other color system (PAL, SECAM, etc.).
- Because of problems and errors that can occur during the creation of DVD and CD software and/or the manufacture of DVD and CD discs, Toshiba cannot assure that this DVD player will successfully play every disc bearing the DVD and CD logos. If you happen to experience any difficulty playing a DVD and/or CD disc on this DVD player, please contact Toshiba Customer Service.

 is a trademark of DVD Format/Logo Licensing Corporation.

# Table of Contents

## Introduction

|   |    |
|---|----|
| ● SAFETY PRECAUTIONS.....                           | 2  |
| ● IMPORTANT SAFETY INSTRUCTIONS.....                | 3  |
| ● Precautions.....                                  | 5  |
| ● Notes on Discs.....                               | 6  |
| Notes on region numbers.....                        | 7  |
| ● Table of Contents.....                            | 8  |
| ● Identification of Controls.....                   | 9  |
| Front panel.....                                    | 9  |
| DVD display.....                                    | 9  |
| Rear panel.....                                     | 10 |
| Remote control.....                                 | 11 |
| Loading batteries.....                              | 14 |
| Operating with the remote control.....              | 14 |
| ● Playing a Disc.....                               | 15 |
| Basic playback.....                                 | 15 |
| Resuming playback from the same location.....       | 16 |
| Locating a specific chapter or track.....           | 16 |
| ● Playing MP3/WMA/Audio CD/JPEG/DivX®<br>Files..... | 17 |

## Connections

|   |    |
|---|----|
| ● Connecting to a TV.....   | 19 |
| Connecting to a TV.....   | 19 |
| Connecting to an audio system and TV<br>equipped with component video inputs..... | 20 |
| ● Connecting to Optional Equipment.....   | 21 |
| Connecting to an amplifier equipped with a<br>Dolby® Digital decoder.....         | 21 |
| Connecting to an amplifier equipped with<br>Dolby Surround Pro Logic.....         | 21 |
| Connecting to an amplifier equipped with a<br>DTS® decoder.....                   | 22 |
| Connecting to an amplifier equipped with an<br>MPEG2 audio decoder.....           | 22 |
| Connecting to an amplifier equipped with a<br>digital audio input.....            | 22 |

## Function setup

|  |    |
|--|----|
| ● Customizing the Function Settings..... | 23 |
| Setting procedure.....                   | 23 |
| Setting details.....                     | 23 |
| ● Table of Languages.....                | 28 |

## Others

|   |    |
|---|----|
| ● Before Calling Service Personnel..... | 29 |
| ● Specifications.....                   | 31 |
| ● Limited United States Warranty.....   | 32 |
| ● Limited Canadian Warranty.....        | 34 |



# Identification of Controls

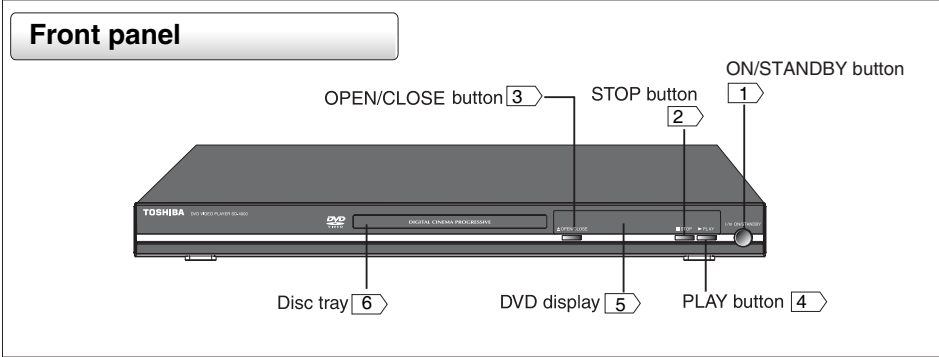

1. ON/STANDBY button  
Press to toggle the player between ON and OFF.
2. STOP button  
During DVD playback, press once to stop playback. The unit records the stopped point, depending on the disc. Press PLAY button to resume playback from the stopped point. If you press this button again, the unit will clear the stopped point causes the disc to return to the beginning of the disc if playback starts again.
3. OPEN/CLOSE button  
Press to open and close the disc tray.
4. PLAY button  
Press to play the disc.
5. DVD display  
Display current disc information.
6. Disc tray  
When loading a disc, place the disc in the disc tray with the label side facing up.

## DVD display

The indicators vary depending on the kinds of discs you play.

|  |  |  |             |   |  |
|--|--|--|-------------|---|--|
| <p>No disc</p>   |  | <p>Bad disc</p>  |             | <p>Chapter/Track number indicator</p> <p>Multifunctional indicator (indicates operating status or messages, etc.)</p> |  |
| <p>DVD video disc</p> <p>•During playback:<br/>Example</p> <p>Some discs may only display chapter numbers.</p> | <p>VIDEO CD</p> <p>•During playback:<br/>Example</p> <p>Some discs may only display track numbers.</p> | <p>Audio CD</p> <p>•During playback:<br/>Example</p> <p>Some discs may only display track numbers.</p> | <p>OPEN</p> |   |  |

## Identification of Controls

**Rear panel**

VIDEO OUT (Y/Pb/Pr)  
(Component video) jacks [4]

COAXIAL DIGITAL  
AUDIO OUT jack [5]

AC inlet  
To wall outlet

S VIDEO OUT jack [2]

VIDEO OUT jack [3]

ANALOG AUDIO OUT (L/R)  
jacks [1]

- 1. ANALOG AUDIO OUT (L/R) jacks**  
Use audio/video cable supplied to connect to TV or monitor with audio/video inputs.
- 2. S VIDEO OUT jack**  
If the TV has an S video input, connect the DVD video player with the S video cable. When using the S video cable, do not connect the yellow video cable and component video cables (Y/PB/PR).
- 3. VIDEO OUT jack**  
Connect the video output to TV or monitor with audio/video inputs capability.
- 4. VIDEO OUT (Y/PB/PR)(Component video) jacks**  
If your TV or monitor or other similar devices has component video inputs, you can produce a higher quality picture on it by connecting its component video cable to the Y/PB/PR jack on this unit.
- 5. COAXIAL DIGITAL AUDIO OUT jack**  
Use to output digital audio recorded on discs by connecting to the coaxial digital audio input on an AV amplifier or receiver with digital audio input capability, but first you need to change the setting to digital audio output on the SETUP MENU.

# Identification of Controls (continued)

The instructions in this manual describe the functions on the remote control.

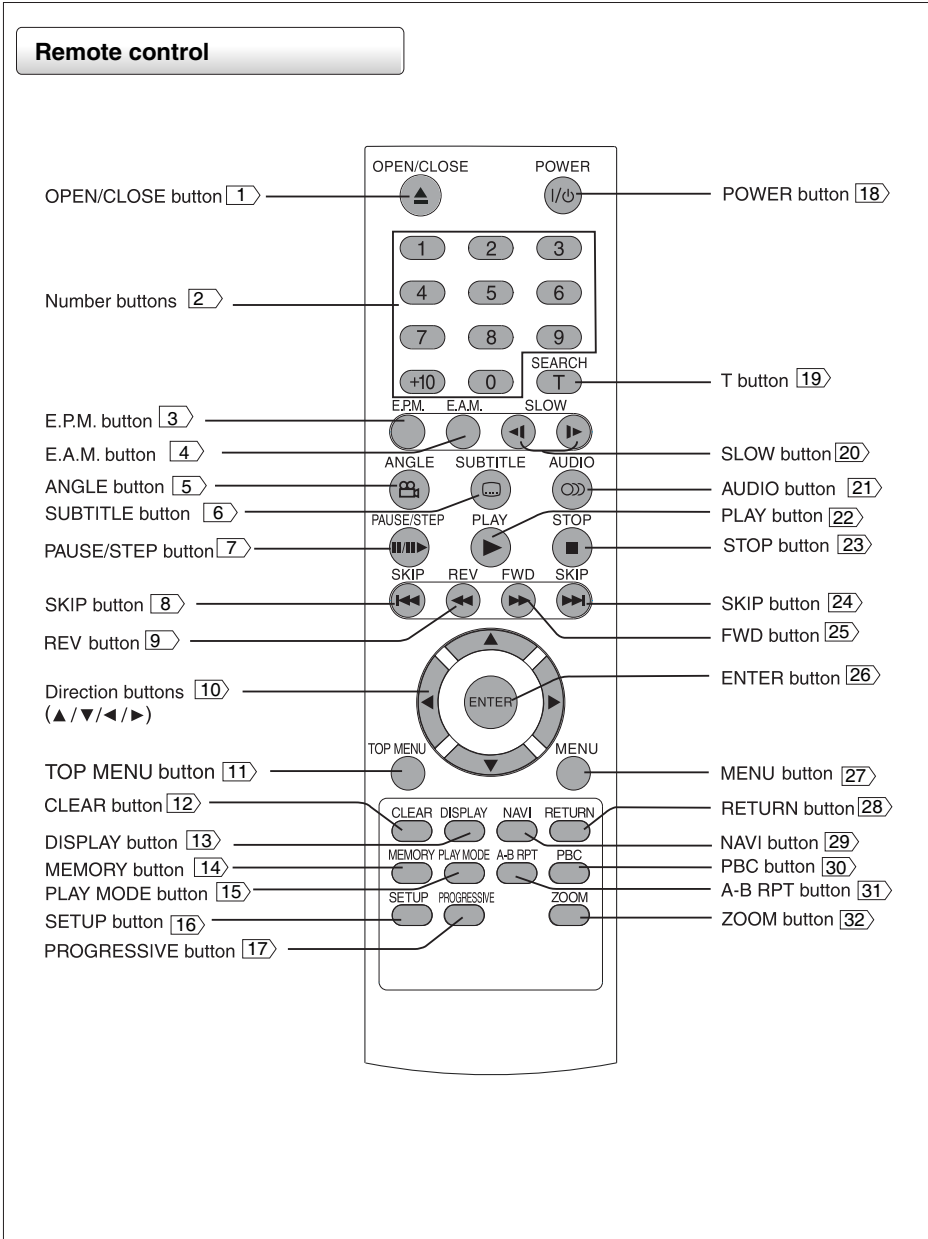

Introduction

## Identification of Controls (continued)

The instructions in this manual describe the functions on the remote control. Please see below:

### 1 OPEN/CLOSE button

Press to OPEN/CLOSE the disc tray.

### 2 Number buttons

Press number buttons to play relevant chapter/track.

### 3 E.P.M. button

Use to select the picture enhancement.



Select the picture enhancement by pressing ▲/▼, then press ◀/▶ to make your selections.

To exit the picture enhancement selection, press E.P.M. again.

### 4 E.A.M. button

Use to toggle the sound enhancement on or off when DVD discs is Dolby Digital 5.1Ch and "Digital Output" is PCM or Off.



### 5 ANGLE button

While playing a scene recorded with multiple angles, press the ANGLE button.  
e.g.



Number changes to show the number of the current angle. (The maximum number of possible angles is 9.)

ANGLE button is also use to change the picture transition mode of JPEG playback.

Press ANGLE button during JPEG playback will change the picture transition mode as follows:

Wipe Down  
Wipe Up  
Center In  
Center Out  
Blind Down  
Blind Up  
Random  
None

During slide show playback and when "Loading..." is displayed, ANGLE button is not allowed to operate. The prohibited sign "⊘ Not allowed at the moment" will be displayed on the TV screen.

### 6 SUBTITLE button

For DVD discs, press this button to change the language of the subtitle.

To turn off the subtitle, press SUBTITLE several times until "Off" appears on the screen.

#### Notes

- The numbers of languages vary with the DVD discs.
- When you select a subtitle language which is not included on the disc, the DVD video player plays a prior language programmed on the disc.
- During some scenes, the subtitles may not appear immediately after you change the subtitle language.

### 7 PAUSE/STEP button

Press PAUSE/STEP to freeze playback.

During still playbacks, each time you press the PAUSE/STEP button, the picture advances one frame.

⏸ Pause → ⏩ Step



### 8 SKIP ⏮ button

Press SKIP ⏮ once within 5 seconds of playback to skip to the previous chapter/track. If you press the button after 5 seconds, it will start playback from the beginning of the current chapter/track.

### 9 REV ⏪ button

Scan in fast reverse on DVD and other discs.

Press this button to toggle among the following modes: ◀X2 → ◀X8 → ◀X30 → ◀X100 → ◀X2.

### 10 Direction buttons

Use UP/DOWN/RIGHT/LEFT to select a function in the setup menu.

During JPEG playback, press the ▶ repeatedly to rotate the image clockwise by 90,180 or 270 degree. Press the ◀ repeatedly to rotate the image counter clockwise by 270, 180 or 90 degree. When in Zoom mode, this function does not work.

### 11 TOP MENU button

Display the title menu on DVD Disc.

When playing JPEG, if you press TOP MENU in full screen review, the DVD video player will display a menu of 9 thumbnail images.

If you display the top menu during playback and press the TOP MENU button again without selecting any title, the DVD video player may resume playback from the point where you first pressed the TOP MENU button (depending on the actual DVD video disc.).

### 12 CLEAR button

Use CLEAR to delete the scheduled program or to cancel input data in the setting mode.

### 13 DISPLAY button

Bring up the on screen display showing the information of the current playing status.

### 14 MEMORY button

Press this button, the OSD will show as below:

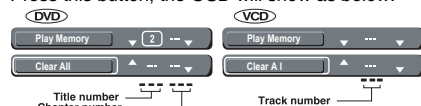

You can use the cursor button (◀/▶/▲/▼) and number buttons to input your desired title/chapter/track. You can program up to 12 selections into the memory (Memory playback). When you have finished programming, you can move the cursor to the Play Memory, then press the ENTER button to start the playback. The programmed selections will be cleared when you turn off the DVD video player.

### 15 PLAY MODE button

Press PLAY MODE button to select desired features using ▲/▼ and then press ENTER button to toggle desired mode.

## Identification of Controls (continued)

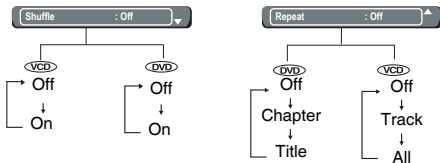

**Chapter:** Repeats the current chapter.  
**Title:** Repeats all chapters within the current title.  
**Track:** Repeats the current track.  
**All:** Repeats the entire disc.  
**Off:** Resumes normal playback.

- 16) SETUP button**  
 Access the on-screen Setup menu for settings adjustment.
- 17) PROGRESSIVE button**  
 Press to change the output signal for better picture quality during stop mode. (See page 20.)
- 18) POWER button**  
 Turn the unit on or set the unit to Standby mode.
- 19) T button**  
 You may press T and then press ▲/▼ to select Title search / Chapter or Track search and Time search. When you select a chapter/track number greater than "10", press number "1" plus any single number. Then press ENTER. For example, if you want to select chapter/track 12, just press the number button "1" and "2". The chapter/track number "12" will appear on the Search menu screen. Then press ENTER. But if you want to select chapter/track number 10, press +10 and then ENTER. If you input a wrong number, press CLEAR button.



Press T twice, the display of Bookmark appears, then press ENTER to mark the desired scene. Press T again to turn off this display.

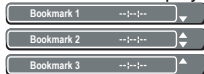

**Note**  
 For VCD, Track Time and Disc Time selection is not possible if the PBC mode is on.

- 20) SLOW button**  
 Reverse/Forward slow playback. Press this button to toggle among the following modes: 1▶1/2 → 1▶1/4 → 1▶1/8 → 1▶1/2 / ◀1/2 → ◀1/4 → ◀1/8 → ◀1/2.
- 21) AUDIO button**  
 For DVD discs, press this button to toggle between different audio modes. The selected audio mode will be displayed on the screen. For stereo discs, press to switch the audio channel output. Remarks: For bilingual edition VCD discs, press the AUDIO button to select your audio channel (Left, Right, Mix or Stereo).

- 22) PLAY button**  
 Press to Start playback.
- 23) STOP button**  
 Press once to stop playback and hold the last position in memory. Playback can be resumed where it was left off by pressing PLAY. Press twice to clear the last playback position.
- 24) SKIP ►► button**  
 Advanced to the next chapter/track on DVD and other discs.
- 25) FWD ►► button**  
 Scan in fast forward on DVD and other discs. Press this button to toggle among the following modes: ►►X2 → ►►X8 → ►►X30 → ►►X100 → ►►X2.
- 26) ENTER button**  
 Selects options in menus. Plays a disc, chapter or track with some discs. For other discs, press PLAY.
- 27) MENU button**  
 Display the menu of DVD disc.
- 28) RETURN buttons**  
 When navigating disc menus, press to return to the previous menu accessed.
- 29) NAVI buttons**  
 Press to display and access features and Settings. Select by pressing ◀/▶ then press ENTER to access the feature.



- : To stop playback.
- ◀◀ : Playback starts from the beginning of the current chapter or track.
- ▶▶ : To start playback.
- ▶▶▶ : To locate succeeding chapters or tracks.
- || : To pause playback.

- 30) PBC button**  
 Press to toggle between PBC On and PBC Off. (Only applicable to VCD2.0/SVCD discs)
- 31) A-B REPEAT button**  
 Set the beginning and end points of a section to repeat.  
**Notes**
- Some discs may not permit A-B repeat operation.
  - There may be a slight difference between point and the location where playback actually resumes depending on the disc.
- 32) ZOOM button**  
 Press this button to zoom in the current picture. There are three zooming modes. Press cursor buttons (▲/▼/◀/▶) to view a different part of the zoom in image. You may move the image from the centre position to UP, DOWN, LEFT, RIGHT direction. To resume normal playback, press ZOOM button repeatedly until the "◯ Off" is displayed.  
**Notes**
- The magnification level varies depending on the picture size you select.
  - Some discs may not respond to ZOOM feature.

## Loading batteries

### 1 Open the cover.

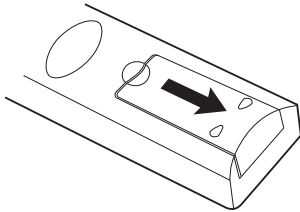

### 2 Insert batteries (AAA size).

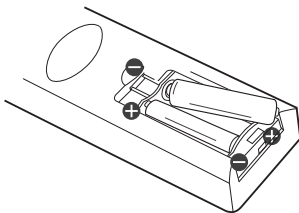

Make sure to match the + and - on the batteries to the marks inside the battery compartment.

#### Caution:

Never throw batteries into a fire.

#### Notes

- Be sure to use AAA size batteries.
- Dispose of batteries in a designated disposal area.
- Batteries should always be disposed of with the environment in mind.  
Always dispose of batteries in accordance with applicable laws and regulations.
- If the remote control does not operate correctly, or if the operating range becomes reduced, replace batteries with new ones.
- When necessary to replace batteries in the remote control, always replace both batteries with new ones.  
Never mix battery types or use new and used batteries in combination.
- Always remove batteries from remote control if they are dead or if the remote control is not to be used for an extended period of time. This will prevent battery acid from leaking into the battery compartment.

## Operating with the remote control

Point the remote control at the remote sensor and press the buttons.

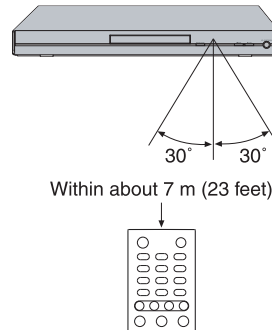

Distance: About 7 m (23 feet) from the front of the remote sensor

Angle: About 30° in each direction of the front of the remote sensor.

\* Do not expose the remote sensor of the DVD video player to a strong light source such as direct sunlight or other illumination. If you do so, you may not be able to operate the DVD video player via the remote control.

#### Notes on the remote control

- Direct the remote control at the remote sensor of the DVD video player.
- When using the remote control, press the buttons at intervals of about 1 second to ensure the correct mode of operation.
- Do not drop or give the remote control a shock.
- Do not leave the remote control near an extremely hot or humid place.
- Do not spill water or put anything wet on the remote control.
- Do not open the remote control.

# Playing a Disc

This section shows you the basics on how to play a disc.

## CAUTION

Keep your fingers well clear of the disc tray as it is closing. Neglecting to do so may cause serious personal injury.

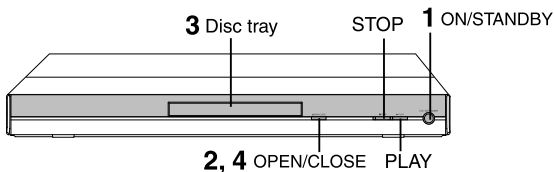

## Basic playback

### Preparations

- When you want to view a disc, turn on the TV and select the video input connected to the DVD video player.
- When you want to enjoy the sound of discs from the audio system, turn on the audio system and select the input connected to the DVD video player.

### 1 Press the ON/STANDBY button.

POWER The DVD video player turns on.



### 2 Press OPEN/CLOSE.

OPEN/CLOSE



The disc tray opens.

### 3 Place the disc on the disc tray.

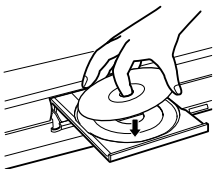

With the playback side down

- There are two different disc sizes. Place the disc in the correct guide on the disc tray. If the disc is out of the guide, it may damage the disc and cause the DVD video player to malfunction.
- Do not place a disc which is unplayable in this DVD video player.

### 4 Press OPEN/CLOSE to close the disc tray.

OPEN/CLOSE Playback starts.



If you insert a DVD video disc that contains a top menu, a menu may appear. Use the ▲/▼/◀/▶ to select the title you want to view, then press ENTER to start playback.

- You may need to press the TOP MENU or MENU button to display disc menu (depending on the actual DVD video disc.).

### Notes

- If the disc tray is holding a disc you have already played, playback will begin from the location where you last stopped. For resuming playback, see page 16.
- Some video CD are recorded with PBC (Playback Control), a menu with recorded contents may appear on the TV if you have turned the PBC On. You can make your selection according to its PBC menu. Press the PBC button on the remote control to turn PBC On or Off anytime during Video CD playback. When switching from PBC Off to PBC On mode, playback will start from the beginning of the disc.

### ■ To start playback in the stop mode

Press **PLAY**.

PLAY



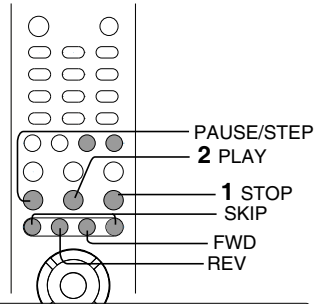



**DVD VCD CD Resuming playback from the same location**

- 1 Press STOP at the location where you want to interrupt playback.**

**STOP** The DVD video player memorizes the location where playback is stopped.

- 2 Press PLAY.**

**PLAY** The DVD video player resumes playback from the location where you stopped playback.







**To start playback from the beginning regardless of the location where you stopped playback**

- 1 Press STOP twice.**

**STOP** The DVD video player deletes the memory of the location.

- 2 Press PLAY.**

**PLAY**
  -  Playback starts from the beginning of the current title.
  -  Playback starts from the beginning of the disc.
  -  Playback starts from the beginning of the current track.





**Notes**

- Resuming cannot function when:
  - you play a PBC featured VIDEO CD while "PBC" is set to "On".
  - you open the disc tray.
  - you disconnect the power plug of the DVD video player.
- There may be a difference in the location where playback resumes depending on the disc.
- Settings you changed using the on screen displays while the DVD video player keeps a location in the memory may function only after the memory is cleared.

- If you want to return to the beginning of a DVD video disc, open and close the disc tray once with the OPEN/CLOSE button before pressing the PLAY button.

**DVD VCD CD Locating a specific chapter or track**

- Press SKIP ►► or ◀◀ repeatedly to access the chapter or track number you want.**  
 Playback starts from the selected chapter or track.
- SKIP** To locate succeeding chapters or tracks by pressing the button once.
- 
- SKIP** To locate previous chapter or track by pressing the button once within 5 seconds after playback.
- 
- If you press the button once after 5 seconds, it will start playback from the beginning of the current chapter or track.

- Note**
- Some titles may not display chapter numbers.



# Playing MP3/WMA/Audio CD/JPEG/DivX® Files

## ■ Play modes for MP3/WMA/Audio CD/JPEG/DivX®

When you play MP3/WMA/Audio CD/JPEG/DivX®, users are able to modify the Play modes through the Toolkit which appears on the right of below picture on the screen. Press ◀/▶ button to navigate between the windows and ▲/▼ button to select files/tracks or play mode items. Then press ENTER button. Please refer to below steps to playback files/tracks in the Memory View list:

- 1) Select Edit Mode in the Toolkit then press ENTER button to start Edit Mode.
- 2) Select a file/track or more files/tracks you want in the Original View list.
- 3) Select Add To Memory in the Toolkit then press ENTER. “✓” will disappear from the screen. It means that the files/tracks you have selected already added into the Memory View list.
- 4) Select Memory View in the Toolkit then press ENTER to open the files/tracks in the Memory View list that you already selected in step 2.
- 5) Press PLAY to playback all files/tracks in the Memory View list.

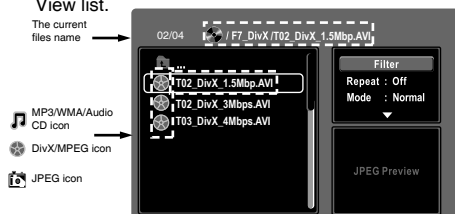

The Toolkit has the following play mode items:

- **Filter (Audio/Photo/Video):** Sets file filters.

- **Repeat (Off/Track/All):**

- Off : Resumes normal playback.
- Track : Repeats the current track/file.
- All : Repeats all files on the current folder or all tracks on the disc.

- **Mode (Normal/Shuffle/Random/Intro):**

- Normal: Resumes normal playback.
- Shuffle: Playbacks track/file in random order.
- Random: Playbacks track/file in random order, and will repeat playback the same track/file more than one time.

Intro: Only playbacks the first 10 seconds of all the files on the current folder or all tracks on the disc.

- **Edit Mode:** Memory operation works only when Edit Mode is selected.

- **Memory View:** To view tracks/files in the Memory View list. It is disabled when the Memory View list is empty.

- **Add To Memory:** Add files/tracks to the Memory View list. It is disabled if the Edit Mode is not selected. (Only 10 files/tracks can be selected each time to add to memory. The maximum number of files/tracks can be added is 30.)

- **Browser View :** To view files/tracks in the Original View list.

- **Clear:** Delete the files/tracks in the Memory View list. Select a file/track or more you want to delete in stop mode. “✓” will appear beside the deleted file/track. Select Clear and then press ENTER. It is disabled if the Edit mode is not selected.

### Notes

- DivX® & JPEG do not support Intro mode.
- Filter is not applicable to Audio CD.

### ■ Playable files

MP3/WMA disc compatibility with this player is limited as follows:

- Playable discs: CD-R (650MB / 74 min. only)  
CD-RW maybe not recommendable.
- Sampling Frequency: 44.1 kHz only
- Bit rate: WMA: 48 kbps - 192 kbps (CBR\*)  
MP3: 32 kbps - 320 kbps (CBR\*)
- CD physical format: Mode 1, Mode 2 XA Form 1
- File system: ISO9660 Level 1, 2 or Joliet
- File name: A file name should be in alphabet and numerals only, and must incorporate "MP3" or "WMA" extension. e.g. "\*\*\*\*\*.MP3", "\*\*\*\*\*.WMA"

- Total number of folders: Less than 256
  - Total number of files: Less than 1000
  - WMA codec version: V7 or V8 (Stereo sound only)
- \* CBR = Constant Bit Rate

This DVD player requires discs/recordings to meet certain technical standards in order to achieve optimal playback quality. There are many different types of recordable disc formats (including CD-R containing MP3/WMA files). Not all recordable discs will operate or produce optimal playback quality. The technical criteria set forth in this owner's manual are meant only as a guide. Use of CD-RW for MP3 files is not recommended.

You must obtain any required permission from copyright owners to download or use copyrighted content. Toshiba cannot and does not grant such permission.

Microsoft, Windows Media, and the Windows Logo are either registered trademarks or trademarks of Microsoft Corporation in the United States and/or other countries.



### Notes

- When the WMA or MP3 file is out of the above specifications, the song may skip or mute with counter moving.
- You can play in fast reverse or fast forward during MP3 and DivX® playback but not WMA playback.
- During MP3 and DivX® playback, press T button to search "Track Time". It is not applicable to WMA.

### ■ JPEG files compatibility

Discs whose compatibility with this DVD video player has been confirmed by TOSHIBA are as follows. Many of these discs, when loaded, will make the DVD video player enter the automatic mode to play a prescribed folder in the disc. To play other folders, display a folder list and select a folder.

CANON QuickCD      FUJICOLOR CD      Kodak Picture CD      NORITSU QSS CD

JPEG disc compatibility with this DVD video player is limited as follows:

- Playable discs:                    CD R (650MB / 74 min. only)  
  CD RW maybe not recommendable.
- CD physical format:              Mode 1, Mode 2 XA Form 1
- File system:                        ISO9660 Level 1, 2 or Joliet
- File name:                         A file name should be in alphabet and numerals only, and must incorporate "JPG" extension. e.g. "\*\*\*\*\*.JPG" (Do not name the file with "JPE" or "JPEG" extension.)
- Total number of folders:        Less than 256
- Total number of files:            Less than 1000

Depending on the file size, some files may not display the entire image.

Some discs may not permit this operation. Especially, the following conditions of included files will increase the disc's disability.

1. Pixels over 3072 x 2048 in height and/or width
2. File format except Exif

### ■ DivX® Playable files

DivX® disc compatibility with this player is limited as follows:

- Playable discs:                    CD R (650MB / 74 min. only)  
  CD RW maybe not recommendable.
- Audio format:                      CBR MP3, VBR MP3, DivX® AC3
- Enhance video:                    GMC, Qpel, Progressive B frames
- Frame rate:                         8 to 25 fps
- CD physical format:              Mode 1, Mode 2 X A Form 1
- File system:                        ISO9660 Level 1, 2 or Joliet
- File name:                         A file name should be in alphabet and numerals only, and must incorporate "AVI" extension. e.g. "\*\*\*\*\*.AVI"
- Total number of folders:        Less than 256
- Total number of files:            Less than 1000

DivX, DivX Certified, and associated logos are trademarks of DivX, Inc. and are used under license.

### Notes

- It is recommended to record same kind of files in a CD R.
- Some DivX® Video On Demand files may require registration code of your DVD Video player, you may get the code in Default Setting. (Page 27)

# Connecting to a TV

Connect the DVD video player to your TV.

## Connecting to a TV

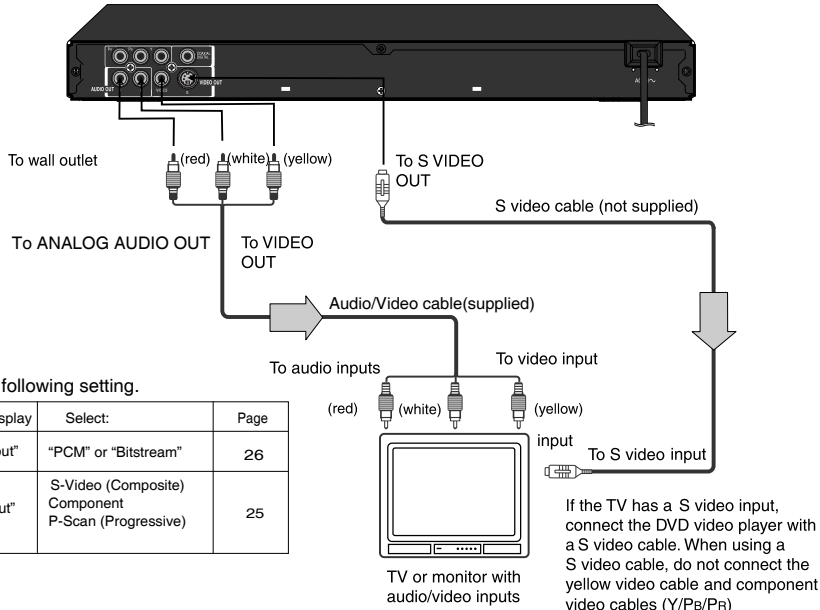

- Make the following setting.

| On-screen display | Select:  | Page |
|-------------------|--|------|
| "Digital Output"  | "PCM" or "Bitstream"                                     | 26   |
| "Video Output"    | S-Video (Composite)<br>Component<br>P-Scan (Progressive) | 25   |

### Notes

- Refer to the owner's manual of the connected TV as well.
- When you connect the DVD video player to your TV, be sure to turn off the power and unplug both units from the wall outlet before making any connections.
- If your television set has one audio input, connect the left and right audio outputs of the DVD video player to a Y cable adapter (not supplied) and then connect to your TV.
- Connect the DVD video player directly to your TV. If you connect the DVD video player to a VCR, TV/VCR combination or video selector, the playback picture may be distorted as DVD video discs are copy protected.
- Analog audio out will not have sound if DTS playback is selected.

### Interlaced outputs (ColorStream®)

Some TVs or monitors are equipped with component video inputs. Connecting to these inputs allows you to enjoy higher quality picture playback.

Actual labels for component video inputs may vary depending on the TV manufacturer. (ex. Y, R-Y, B-Y or Y, Cb, Cr).

In some TVs or monitors, the colour levels of the playback picture may be reduced slightly or the tint may change. In such a case, adjust the TV or monitor for optimum performance.

### Progressive outputs (ColorStream Pro®)

Some TVs or monitors are equipped with component video inputs that are capable of reproducing a progressively scanned video signal.

Connecting to these inputs allows you to view the highest quality pictures with less flicker.

Consumers should note that not all high definition television sets are fully compatible with this product and may cause artifacts to be displayed in the picture.

In case of 525 progressive scan picture problems, it is recommended that the user switch the connection to the "standard definition" output. If there are questions regarding our TV set compatibility with this model 525p DVD player, please contact our Customer Service Center.

**Connecting to an audio system and TV equipped with component video inputs**

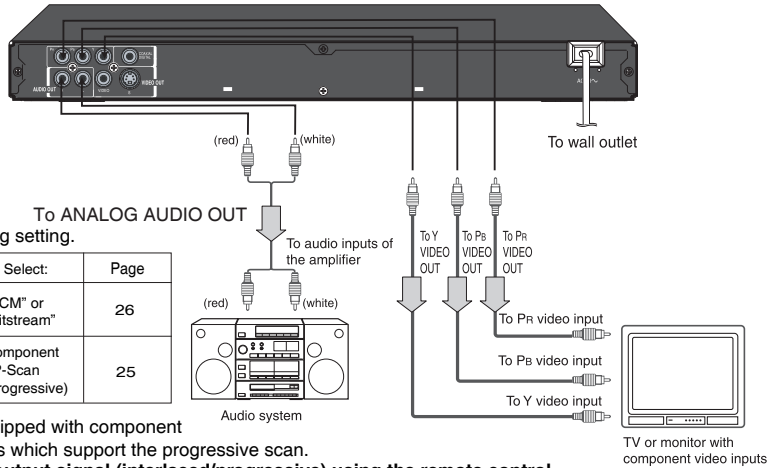

- Make the following setting.

| On-screen display | Select:                          | Page |
|-------------------|----------------------------------|------|
| "Digital Output"  | "PCM" or "Bitstream"             | 26   |
| "Video Output"    | Component "P-Scan (Progressive)" | 25   |

\* Only for TV equipped with component video input jacks which support the progressive scan.

■ **Switching the output signal (interlaced/progressive) using the remote control**

You can temporarily switch the output signal for better picture quality.

Press **PROGRESSIVE** on the remote control during stop mode.

Press **PROGRESSIVE** again to turn off progressive mode.

If your TV does not support the progressive scan format, the picture will appear scrambled or blank. To return to normal picture, press **PROGRESSIVE** button again to turn off progressive mode.

**Notes**

- Refer to the owner's manual of the connected equipment as well.
- When you connect the DVD video player to other equipment, be sure to turn off the power and unplug all of the equipment from the wall outlet before making any connections.
- If you place the DVD video player near a tuner or radio, the radio broadcast sound might be distorted. In this case, place the DVD video player away from the tuner and radio.
- The output sound of the DVD video player has a wide dynamic range. Be sure to adjust the receiver's volume to a moderate listening level. Otherwise, high volume sound may damage your hearing as well as the speakers.
- Turn off the amplifier before you connect or disconnect the DVD video player's power cord. If you leave the amplifier power on, the speakers may be damaged.
- Progressive can be on/off only when "Video Output" is set to Component or P-Scan. (Page 25)
- In component connections, the screen might become pinkish in color when the "Video Output" is set to S-Video. This is not a defect of this unit.
- Analog audio out will not have sound if DTS playback is selected.
- When using component video cables, do not connect the S-Video cable.
- The relation between Video Output setting and content output for each output jack is as following tabulation:

| User setting/operation | content output for each output jack |              |                  |
|------------------------|-------------------------------------|--------------|------------------|
| Video output setting   | S-video output                      | Video output | Component output |
| S-Video(composite)     | Composite                           | Composite    | —                |
| Component(interlaced)  | —                                   | Composite    | Interlaced       |
| P-Scan(progressive)    | —                                   | Composite    | Progressive      |

ColorStream® and ColorStream Pro® are registered trademarks of Toshiba America Consumer Products, L.L.C.

## Connecting to Optional Equipment

You can enjoy high quality dynamic sounds by connecting the DVD video player to optional audio equipment.

### Connecting to an amplifier equipped with a Dolby® Digital decoder

#### Dolby Digital

Dolby Digital is the surround sound technology used in theaters showing the latest movies, and is now available to reproduce this realistic effect in the home. You can enjoy motion picture and live concert DVD video discs with this dynamic realistic sound by connecting the DVD video player to a 6 channel amplifier equipped with a Dolby Digital decoder or Dolby Digital processor. If you have a Dolby Surround Pro Logic decoder, you will obtain the full benefit of Pro Logic from the same DVD movies that provide full 5.1 channel Dolby Digital soundtracks, as well as from titles with the Dolby Surround mark.

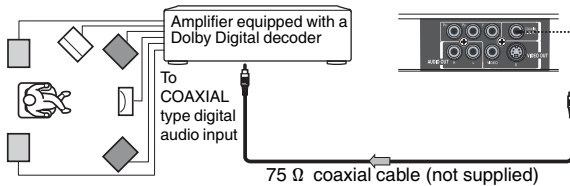

Manufactured under license from Dolby Laboratories. "Dolby" and the double D symbol are trademarks of Dolby Laboratories.

- Use DVD video discs encoded via the Dolby Digital recording system.
- Make the following setting.

| On screen display | Select:              | Page |
|-------------------|----------------------|------|
| "Digital Output"  | "PCM" or "Bitstream" | 26   |

### Connecting to an amplifier equipped with Dolby Surround Pro Logic

#### Dolby Surround Pro Logic

You can enjoy the dynamic realistic sound of Dolby Surround Pro Logic by connecting an amplifier and speaker system (right and left front speakers, a center speaker, and one or two rear speakers).

- With an amplifier equipped with Dolby Digital  
Connect the equipment the same way as described in "Connecting to an amplifier equipped with a Dolby Digital decoder." Refer to that amplifier's owner's manual and set the amplifier so you can enjoy Dolby Surround Pro Logic sound.
- With an amplifier not equipped with Dolby Digital  
Connect the equipment as follows.

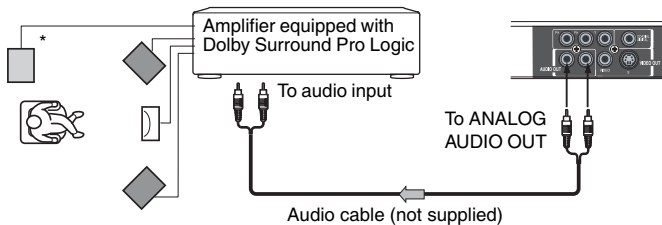

- Make the following setting.

| On screen display | Select:              | Page |
|-------------------|----------------------|------|
| "Digital Output"  | "PCM" or "Bitstream" | 26   |

\* Connect one or two rear speakers.  
The output sound from the rear speakers will be monaural even if you connect two rear speakers.

## Connecting to Optional Equipment(continued)

### Connecting to an amplifier equipped with a DTS® decoder

#### Digital Theater Systems (DTS)

DTS is a high quality surround technology used in theaters and now available for home use, on DVD video discs or audio CDs. If you have a DTS decoder or processor, you can obtain the full benefit of 5.1 channel DTS encoded sound tracks on DVD video discs or audio CDs.

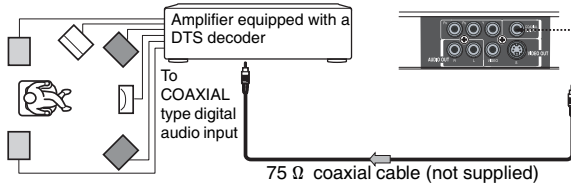

"DTS" and "DTS Digital Out" are registered trademarks of DTS, Inc.

- Use DVD video discs or audio CDs encoded via the DTS recording system.
- Make the following setting.

| On screen display | Select:     | Page |
|-------------------|-------------|------|
| "Digital Output"  | "Bitstream" | 26   |

### Connecting to an amplifier equipped with an MPEG2 audio decoder

#### MPEG2 sound

You can enjoy motion picture and live concert DVD video discs with dynamic realistic sound by connecting an amplifier equipped with an MPEG2 audio decoder or MPEG2 audio processor.

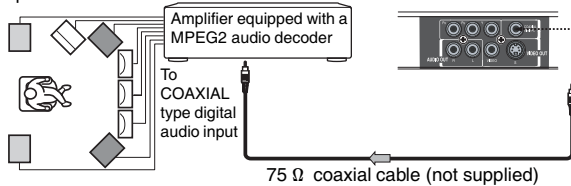

- Use DVD video discs encoded via the MPEG2 recording system.
- Make the following setting.

| On screen display | Select:              | Page |
|-------------------|----------------------|------|
| "Digital Output"  | "PCM" or "Bitstream" | 26   |

### Connecting to an amplifier equipped with a digital audio input

#### 2 channel digital stereo

You can enjoy the dynamic sound of 2 channel digital stereo by connecting an amplifier equipped with a digital audio input and speaker system (right and left front speakers).

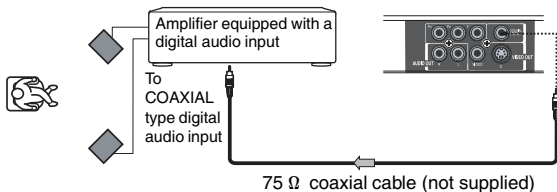

- Make the following setting.

| On screen display | Select: | Page |
|-------------------|---------|------|
| "Digital Output"  | "PCM"   | 26   |

# Customizing the Function Settings

## Setting procedure DVD VCD CD

### Setting procedure

Press the SETUP button to display the main menu on the screen. When the setup menu is shown, the playback will be automatically paused.

1. Press ▲/▼ button to select the desired setup, then press ► button.
2. Press ▲/▼ button to select the sub menu, then press ENTER.
3. Change the selection by ▲/▼ button, by referring to the corresponding pages, then press ENTER.
4. To select another option, press ◀ button to go back to step 1.
5. Press the SETUP button again to remove the setup menu from the screen.

### About the screen saver

When you leave the unit in DVD stop mode for approximately 2 minutes, the screen saver of the DVD video player automatically appears. To turn off the screen saver, press the PLAY button.

### Tray Lock

Press SETUP button, and then press the number button 2005 to lock the tray.

#### Note

After the tray is locked, "Tray Lock Is On" will appear on the screen when OPEN/CLOSE button is pressed.

To unlock the tray, just follow the same procedure as above.

### Automatic Power Off function

If the DVD video player is stopped, or the screen saver is engaged for approximately 20 minutes, the DVD video player will automatically turn itself off.

Function setup

## Setting details

### Language



### OSD Menu DVD VCD CD

- English: To view on screen displays in English.  
 Français: To view on screen displays in French.  
 Español: To view on screen displays in Spanish.



#### Notes

- Some DVD video discs may be set to display subtitles in a different language other than you selected. A prior subtitle language may be programmed on the disc.
- Some DVD video discs allow you to change subtitle selections only via the disc menu. If this is the case, press the MENU button and choose the appropriate subtitle language from the selection on the disc menu.

### Subtitle DVD

- English: To display subtitles in English.  
 French: To display subtitles in French.  
 Spanish: To display subtitles in Spanish.  
 Auto: To display subtitles in different languages other than you selected.  
 Off: To disable subtitles.

### DivX Subtitle

If your DivX® files include a subtitle file, then you may select a supported DivX® subtitle language from Central European:

- Central : Albanian, Croat, Czech, Dutch, English,  
 European German, Hungarian, Irish, Polish,  
 Romanian, Slovak, Slovene and Serbian

## Setting details



### Notes

- If your DivX® files do not include the subtitle file, you cannot use this selection.
- Supported subtitle file formats: .srt, .sub, .txt, .smi, .ssa, .ass, .psb.

### Audio

English: To play sound tracks in English.  
 French: To play sound tracks in French.  
 Spanish: To play sound tracks in Spanish.

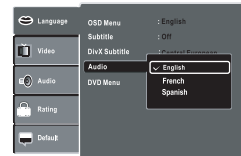

### Note

Some DVD video discs may not be played in a different language that you selected. A prior language may be programmed on the disc.

### DVD Menu

English: To display DVD menus in English.  
 French: To display DVD menus in French.  
 Spanish: To display DVD menus in Spanish.

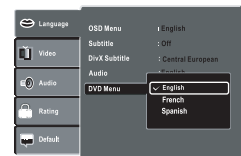

### Note

Some DVD video discs may not include your pre selected language. In this case, the DVD video player automatically displays disc menus consistent with the disc's initial language setting.

## Video

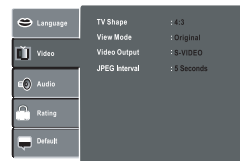

### TV Shape

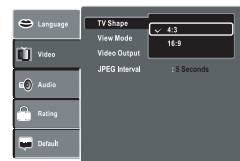

### 4:3



Select when a standard 4:3 TV is connected.  
 Displays pictures cropped to fill your TV screen.  
 Either or both sides of the picture are cut off.

### 16:9

Select when a 16:9 TV is connected

### Notes

- The displayable picture size is preset on the DVD video disc.  
 Therefore, the playback picture of some DVD video discs may not conform to the picture size you select.
- When you play DVD video discs recorded in the 4:3 picture size only, the playback picture always appears in the 4:3 picture size regardless of the TV shape setting.
- If you select "16:9" and you own a 4:3 TV set, the DVD playback picture will be horizontally distorted during playback. Images will appear to be horizontally compressed. Always be sure that your TV shape conforms to the actual TV in use.



# Customizing the Function Settings(continued)

## Setting details

### View Mode

DVD VCD

The user may select one of the following options:

- Fill:** Fill the screen with decoded image.
- Original:** Display image as its original size.
- Height Fit:** Fit the screen height with image height.
- Width Fit:** Fit the screen width with image width.
- Auto Fit:** Automatically fit the decoded image on screen without distortion.
- Pan Scan:** Automatically display decoded image on full screen without distortion.

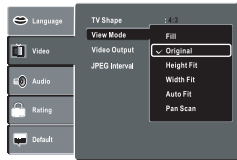

#### Pan Scan



Select when a standard 4:3 TV is connected. Displays pictures cropped to fill your TV screen. Either or both sides of the picture are cut off.

#### Auto Fit



Automatically fit the decoded image on screen without distortion. Black bars will be present on top/bottom or left / right of screen.

#### Note

Depending on the DVD discs, you may not be able to view the mode as selected.

### Video Output

DVD VCD CD

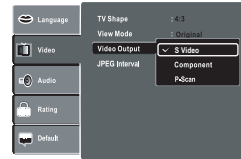

**S Video :** Select if you connect the DVD to TV (Composite) via composite video (yellow) input or S Video input.

**Component:** Select if you connect the DVD to your TV which has component video inputs

**P Scan:** Select if you connect the DVD to your TV which has component video inputs that support progressive scan.

If your TV does not support progressive scan, distorted picture or blank screen will appear when "Yes" option is selected.

In this case, just wait for 15 seconds for auto recovery.

#### Note

At component and P Scan modes, there is no S Video output.

### JPEG Interval

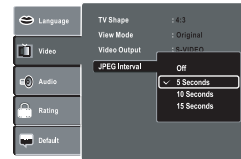

- Off:** Plays back one file at a time.
- 5 Seconds:** Plays back images in the form of a slide show at 5 seconds interval.
- 10 Seconds:** Plays back images in the form of a slide show at 10 seconds interval.
- 15 Seconds:** Plays back images in the form of a slide show at 15 seconds interval.



Function setup

**Audio**

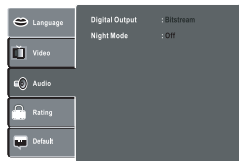

**Digital Output** DVD VCD CD

Selects the output sound format corresponding to your system connection.

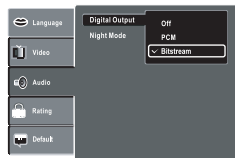

- Off: No digital audio will be output.
- PCM: Select when connected to a 2 channel digital stereo amplifier. The DVD video player outputs sound in the PCM 2 channel format when you play a DVD video disc recorded on the Dolby Digital, MPEG1 or MPEG2 recording system.

Bitstream: Disc audio bitstream data will be output.

**Note**

When you make a connection to a TV, Dolby Surround Pro Logic or stereo system via the analog audio jacks, select "PCM" or "Bitstream".

**Night Mode** DVD VCD CD

Night Mode is equivalent to Dynamic Range Compress. When it is On, it reduces the variation between loud and soft sounds in audio output. You can still hear softer sounds and dialog even in very low volume.

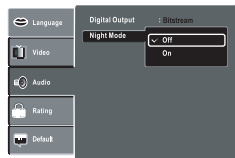

**Note**

Night mode is Dynamic Range Control (DRC) option for analog audio output.

**Rating**

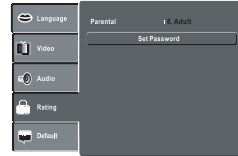

**Parental** DVD

DVD discs equipped with the password function are rated according to their content.

The contents allowed by a parental lock level and the way a DVD disc can be controlled may vary from disc to disc.

For example, if the disc allowed, you could edit out violent scenes unsuitable for children and replace them with more suitable scenes, or you could lock out playback of the disc altogether.

- DVD video discs may or may not respond to the parental lock settings. This is not a defect in the DVD video player. Make sure this function works with your DVD video discs.

- 1) Press SETUP button.
- 2) Press ▲ / ▼ button to select the Rating.
- 3) Press ► button, then the ENTER button to select the Parental.  
"Enter Password" screen will appear.

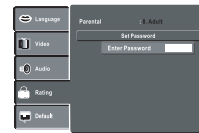

- 4) Press "8888" using number buttons. (Please note, this is pre setting password of this unit.) Then press ENTER.

Press ENTER again to list the parental level.

The parental lock level is equivalent to the following

- Parentals:
- Level 1:Kid Safe
- Level 2:G
- Level 3:PG
- Level 4:PG 13
- Level 5:PG R
- Level 6:R
- Level 7:NC 17
- Level 8:Adult

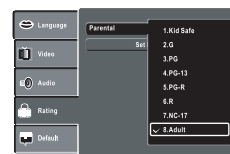

## Customizing the Function Settings(continued)

### Setting details

- 5) Press ▲/▼ to select the Parental from 1 to 8. Parental one (1) has the most restrictions while Parental eight(8) can virtually playback all DVD software.
- 6) Press OPEN/CLOSE button to activate the Parental Level setting.

If the DVD disc has been designed to temporarily cancel the Parental Level, the screen will change depending on which disc is played.

If you select "YES" with the ENTER button, "Enter Password" screen will appear. Input the 4-digit password as you have set then followed by ENTER button and playback will start. If "NO" is selected, press the OPEN/CLOSE to remove the disc.

#### Notes

- If you input wrong password, press CLEAR button and re-enter your 4-digit password again
- You cannot play DVD discs rated higher than the level you selected unless you cancel the parental lock function.

#### Set Password

New Password can be set to replace the default password.

- 1) Press SETUP button.
- 2) Press ▲/▼ button to select the Rating.
- 3) Press ► button, then the ▲/▼ button to select Set Password.
- 4) Press ENTER button. "Enter Password" screen will appear.

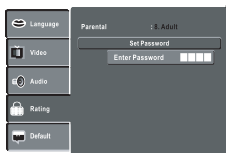

- 5) Press the number buttons to input the current password (If the password has not been set yet after you purchase this unit, it is "8888"). Then press ENTER.
- 6) Press ENTER button again, "Enter New Password" screen will appear. Press the number buttons to input the new password.
- 7) Press ENTER button. Now your new password has been set. Be sure to remember this number!

**If you forget the password, you can erase your current password by pressing number button 8 on the remote control four times, then press ENTER button to confirm the setting.**

**PASSWORD: 8888**

#### Default

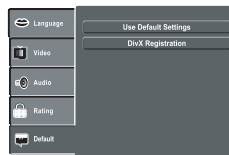

#### Use Default Settings

If you want to return the initial language setting such as Language, Video, Audio and etc. to the factory default, select "Yes" from the following menu.

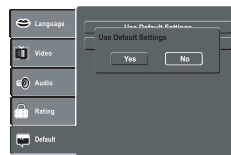

#### Notes

- When you reset the DVD video player to the factory default, the DVD video player will take 3-5 seconds to reset.
- The DVD video player can also be reset to the factory default by pressing the STOP button on the front panel for 5 seconds in tray OPEN mode.

#### DivX Registration

Some DivX® Video-On-Demand files require registration code, please get the code of your DVD video player as follow:

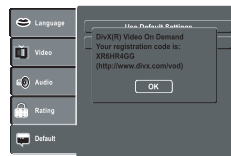

#### Note

This registration code is for DivX® Video-On-Demand only. Do not apply this code for other applications or websites.

## Table of Languages

### Table of languages and their abbreviations

| Abbreviation | Language              | Abbreviation | Language         | Abbreviation | Language       |
|--------------|-----------------------|--------------|------------------|--------------|----------------|
|              | No alternate language | GN           | Guarani          | PT           | Portuguese     |
| CHI (ZH)     | Chinese               | GU           | Gujarati         | QU           | Quechua        |
| DUT (NL)     | Dutch                 | HA           | Hausa            | RM           | Rhaeto Romance |
| ENG (EN)     | English               | HI           | Hindi            | RN           | Kirundi        |
| FRE (FR)     | French                | HR           | Croatian         | RO           | Rumanian       |
| GER (DE)     | German                | HU           | Hungarian        | RU           | Russian        |
| ITA (IT)     | Italian               | HY           | Armenian         | RW           | Kinyarwanda    |
| JPN (JA)     | Japanese              | IA           | Interlingua      | SA           | Sanskrit       |
| KOR (KO)     | Korean                | IE           | Interlingue      | SD           | Sindhi         |
| MAY (MS)     | Malay                 | IK           | Inupiak          | SG           | Sango          |
| SPA (ES)     | Spanish               | IN           | Indonesian       | SH           | Serbo Croatian |
| AA           | Afar                  | IS           | Icelandic        | SI           | Singhalese     |
| AB           | Abkhazian             | IW           | Hebrew           | SK           | Slovak         |
| AF           | Afrikaans             | JI           | Yiddish          | SL           | Slovenian      |
| AM           | Amharic               | JW           | Javanese         | SM           | Samoan         |
| AR           | Arabic                | KA           | Georgian         | SN           | Shona          |
| AS           | Assamese              | KK           | Kazakh           | SO           | Somali         |
| AY           | Aymara                | KL           | Greenlandic      | SQ           | Albanian       |
| AZ           | Azerbaijani           | KM           | Cambodian        | SR           | Serbian        |
| BA           | Bashkir               | KN           | Kannada          | SS           | Siswati        |
| BE           | Belorussian           | KS           | Kashmiri         | ST           | Sesotho        |
| BG           | Bulgarian             | KU           | Kurdish          | SU           | Sundanese      |
| BH           | Bihari                | KY           | Kirghiz          | SV           | Swedish        |
| BI           | Bislama               | LA           | Latin            | SW           | Swahili        |
| BN           | Bengali, Bangla       | LN           | Lingala          | TA           | Tamil          |
| BO           | Tibetan               | LO           | Laotian          | TE           | Telugu         |
| BR           | Breton                | LT           | Lithuanian       | TG           | Tajik          |
| CA           | Catalan               | LV           | Latvian, Lettish | TH           | Thai           |
| CO           | Corsican              | MG           | Malagasy         | TI           | Tigrinya       |
| CS           | Czech                 | MI           | Maori            | TK           | Turkmen        |
| CY           | Welsh                 | MK           | Macedonian       | TL           | Tagalog        |
| DA           | Danish                | ML           | Malayalam        | TN           | Setswana       |
| DZ           | Bhutani               | MN           | Mongolian        | TO           | Tongan         |
| EL           | Greek                 | MO           | Moldavian        | TR           | Turkish        |
| EO           | Esperanto             | MR           | Marathi          | TS           | Tsonga         |
| ET           | Estonian              | MT           | Maltese          | TT           | Tatar          |
| EU           | Basque                | MY           | Burmese          | TW           | Twi            |
| FA           | Persian               | NA           | Nauru            | UK           | Ukrainian      |
| FI           | Finnish               | NE           | Nepali           | UR           | Urdu           |
| FJ           | Fiji                  | NO           | Norwegian        | UZ           | Uzbek          |
| FO           | Faroese               | OC           | Occitan          | VI           | Vietnamese     |
| FY           | Frisian               | OM           | (Afan) Oromo     | VO           | Volapük        |
| GA           | Irish                 | OR           | Oriya            | WO           | Wolof          |
| GD           | Scottish Gaelic       | PA           | Panjabi          | XH           | Xhosa          |
| GL           | Galician              | PL           | Polish           | YO           | Yoruba         |
|              |                       | PS           | Pashto, Pushto   | ZU           | Zulu           |

## Before Calling Service Personnel

Check the following guide for the possible cause of a problem contacting service.

### Symptoms and correction

| Symptom  | Cause  | Correction   |
|--|--|--|
| No power.  | <ul style="list-style-type: none"> <li>The power plug is disconnected.</li> </ul>  | <ul style="list-style-type: none"> <li>Connect the power plug securely into the wall outlet.</li> </ul>  |
| The DVD video player turned off by itself.                             | <ul style="list-style-type: none"> <li>The automatic power off function turned the unit off.</li> </ul>  | <ul style="list-style-type: none"> <li>Press the PLAY button.</li> </ul>   |
| No picture or abnormal color (pinkish, greenish, etc.).                | <ul style="list-style-type: none"> <li>The TV is not set to receive DVD signal output.</li> </ul>  | <ul style="list-style-type: none"> <li>Select the appropriate video input mode on the TV so the picture from the DVD video player appears on the TV screen.</li> </ul>   |
|  | <ul style="list-style-type: none"> <li>Mismatch setting between TV and this unit.</li> </ul>   | <ul style="list-style-type: none"> <li>Select the correct Video Output setting.</li> </ul>   |
|  | <ul style="list-style-type: none"> <li>Wrong connection.</li> </ul>  | <ul style="list-style-type: none"> <li>Check the connection.</li> </ul>  |
|  | <ul style="list-style-type: none"> <li>PROGRESSIVE button is pressed on a TV equipped with component video input jacks but does not support progressive scan.</li> </ul> | <ul style="list-style-type: none"> <li>Press PROGRESSIVE button to turn off progressive mode.</li> </ul>   |
| No sound.  | <ul style="list-style-type: none"> <li>The equipment connected with the audio cable is not set to receive DVD signal output.</li> </ul>                                  | <ul style="list-style-type: none"> <li>Select the correct input mode of the audio receiver so you can listen to the sound from the DVD video player.</li> </ul>          |
|  | <ul style="list-style-type: none"> <li>The audio cable is not connected securely.</li> </ul>   | <ul style="list-style-type: none"> <li>Connect the audio cable securely into the appropriate jacks.</li> </ul>   |
|  | <ul style="list-style-type: none"> <li>The audio receiver or TV is turned off.</li> </ul>  | <ul style="list-style-type: none"> <li>Turn on the equipment connected with the audio cable.</li> </ul>  |
|  | <ul style="list-style-type: none"> <li>The setting of output sound format is incorrect.</li> </ul>   | <ul style="list-style-type: none"> <li>Select the proper audio setting.</li> </ul>   |
| The playback picture has occasional distortion.                        | <ul style="list-style-type: none"> <li>The disc is dirty.</li> </ul>   | <ul style="list-style-type: none"> <li>Remove the disc and clean it.</li> </ul>  |
|  | <ul style="list-style-type: none"> <li>It is in fast forward or fast reverse playback.</li> </ul>  | <ul style="list-style-type: none"> <li>Sometimes a small amount of picture distortion may appear. This is not a malfunction.</li> </ul>                                  |
| Brightness is unstable or noises are present in the playback pictures. | <ul style="list-style-type: none"> <li>The effect of copy protection.</li> </ul>   | <ul style="list-style-type: none"> <li>Connect the DVD video player directly to the TV. Avoid connecting the DVD video player to a VCR or TV/VCR combination.</li> </ul> |

Others

| Symptom  | Cause   | Correction  |
|--|---|---|
| The DVD video player does not start playback.              | • No disc is inserted.  | • Insert a disc.  |
|  | • An unplayable disc is inserted.   | • Insert a playable disc. (Check the disc type and color system.)   |
|  | • The disc is placed upside down.   | • Place the disc with the playback side down.   |
|  | • The disc is not placed within the guide.  | • Place the disc correctly inside the guide on the disc tray.   |
|  | • The disc is dirty.  | • Clean the disc.   |
|  | • The parental lock function is set.  | • Cancel the parental lock function or change the parental lock level.  |
| Playback does not follow the course of the disc's program. | • It is in the mode of repeat playback, memory playback, etc.   | • These operations may prevent a proper progress of the contents.   |
| Buttons do not work.                                       | • Power supply fluctuations or other abnormalities such as static electricity may interrupt correct operations. | • Press and hold the ON/STANDBY button on the front panel for more than about 3 seconds. The DVD video player turns off. Press the button again to turn it on. If the buttons still do not work, disconnect the power plug and insert it into the wall outlet again |
| The remote control does not work properly.                 | • The remote control is not pointed at the remote sensor of the DVD video player.                               | • Point the remote control at the remote sensor of the DVD video player.  |
|  | • The remote control is too far from the DVD video player.  | • Operate the remote control within about 7 m.  |
|  | • The batteries in the remote control are exhausted.  | • Replace the batteries with new ones.  |
| The logo and playing picture of DVD player become poor.    | • Adjust contrast too small or too large.   | • Adjust Brightness or Contrast to a certain level  |
| The DVD player tray does not open.                         | • Tray Lock mode has been enable.   | • Disable the Tray Lock function.   |

# Specifications

## DVD Video player/outputs/supplied accessories

### DVD Video player

|                       |  |
|-----------------------|--|
| Power supply          | 120 V AC, 60 Hz  |
| Power consumption     | 8 W  |
| Mass                  | 1.55kg   |
| External dimensions   | 431 x 40 x 199 mm (W/H/D)  |
| Signal system         | Standard NTSC  |
| Laser                 | Semiconductor laser, wavelength 650/780 nm   |
| Frequency range       | DVD linear sound: 48 kHz sampling 4 Hz to 22 kHz<br>96 kHz sampling 4 Hz to 44 kHz |
| Signal to noise ratio | More than 100 dB   |
| Audio dynamic range   | More than 93 dB  |
| Harmonic distortion   | Less than 70dB   |
| Wow and flutter       | Below measurable level (less than $\pm 0.001\%$ (W.PEAK))                          |
| Operating conditions  | Temperature: 5 °C to 35 °C, Operation status: Horizontal                           |

### Outputs

|                                |  |
|--------------------------------|--|
| Video output                   | 1.0 V (p p), 75 $\Omega$ , negative sync., pin jack x 1  |
| S Video output                 | (Y) 1.0 V (p p), 75 $\Omega$ , negative sync., Mini DIN 4 pin x 1<br>(C) 0.286 V (p p), 75 $\Omega$  |
| Component video output         | (Y) 1.0 V (p p), 75 $\Omega$ , negative sync., pin jack x 1<br>(P <sub>B</sub> )/(P <sub>R</sub> ) 0.7 V (p p), 75 $\Omega$ , pin jack x 2 |
| Audio output (COAXIAL DIGITAL) | 0.5V (p p), 75 $\Omega$ , pin jack x 1   |
| Audio output (ANALOG)          | 2.0 V (rms), 680 $\Omega$ , pin jacks (L, R) x 1   |

### Supplied Accessories

|                                 |   |
|---------------------------------|---|
| Audio/video cable .....         | 1 |
| Remote control (SE R0213) ..... | 1 |
| Batteries (AAA) .....           | 2 |

- This model complies with the above specifications.
- Designs and specifications are subject to change without notice.
- This model may not be compatible with features and/or specifications that may be added in the future.

Others

### Limited United States Warranty

#### Digital Audio Video ("DAV") Product - Exchange Warranty

Toshiba America Consumer Products, L.L.C. ("TACP") makes the following limited warranties to original consumers in the United States.

THESE LIMITED WARRANTIES EXTEND TO THE ORIGINAL CONSUMER PURCHASER OR ANY PERSON RECEIVING THIS DAV PRODUCT AS A GIFT FROM THE ORIGINAL CONSUMER PURCHASER AND TO NO OTHER PURCHASER OR TRANSFEREE.

DAV PRODUCTS PURCHASED IN THE U.S.A. AND USED ANYWHERE OUTSIDE OF THE U.S.A., INCLUDING, WITHOUT LIMITATION, CANADA AND MEXICO, ARE NOT COVERED BY THESE WARRANTIES.

DAV PRODUCTS PURCHASED ANYWHERE OUTSIDE OF THE U.S.A., INCLUDING, WITHOUT LIMITATION, CANADA AND MEXICO, AND USED IN THE U.S.A., ARE NOT COVERED BY THESE WARRANTIES.

---

#### Limited Warranty

TACP warrants this DAV Product and its parts against defects in materials or workmanship for a period of ninety (90) days after the date of original retail purchase.

**DURING THIS PERIOD, TACP WILL EXCHANGE A DEFECTIVE DAV PRODUCT WITH A NEW OR REFURBISHED DAV PRODUCT WITHOUT CHARGE TO YOU. DURING THE PERIOD THAT COMMENCES ON THE DATE THAT IS NINETY ONE (91) DAYS AFTER THE DATE OF ORIGINAL RETAIL PURCHASE AND ENDS ON THE DATE THAT IS THREE HUNDRED SIXTY FIVE (365) DAYS AFTER THE DATE OF ORIGINAL RETAIL PURCHASE, TACP WILL EXCHANGE A DEFECTIVE DAV PRODUCT WITH A NEW OR REFURBISHED DAV PRODUCT FOR A FEE.**

#### Rental Units

The warranty for DAV Product rental units begins on the date of the first rental or thirty (30) days after the date of shipment to the rental firm, whichever comes first.

#### Commercial Units

DAV Products sold and used for commercial purposes have a limited warranty for all parts and labor, which warranty begins on the date of original retail purchase and ends on the date that is ninety (90) days thereafter.

#### Owner's Manual and Product Registration Card

Read this owner's manual thoroughly before operating this DAV Product. Complete and mail the enclosed product registration card or register your DAV Product on line at [www.tacp.toshiba.com/service](http://www.tacp.toshiba.com/service) as soon as possible. By registering your DAV Product you will enable TACP to bring you new products specifically designed to meet your needs and help us to contact you in the unlikely event a safety notification is required under the U.S. Consumer Product Safety Act. Failure to complete and return the product registration card does not diminish your warranty rights.

#### Your Responsibility

THE ABOVE WARRANTIES ARE SUBJECT TO THE FOLLOWING CONDITIONS:

- (1) You must retain your bill of sale or provide other proof of purchase.
- (2) All warranty servicing of this DAV Product must be made pursuant to the TACP DAV Product Warranty Exchange Program.
- (3) The warranties from TACP are effective only if the DAV Product is purchased and operated in the Continental U.S.A. or Puerto Rico.
- (4) Labor service charges for set installation, setup, adjustment of customer controls, and installation or repair of antenna systems are not covered by this warranty. Reception problems caused by inadequate antenna systems are your responsibility.
- (5) Warranties extend only to defects in materials or workmanship as limited above, and do not extend to any DAV Product or parts that have been lost or discarded by you or to damage to the DAV Product or parts caused by fires, misuse, accident, Acts of God (such as lightning or fluctuations in electric power), improper installation, improper maintenance, or use in violation of instructions furnished by TACP; use or malfunction through simultaneous use of this DAV Product and connected equipment; or to units that have been modified or had the serial number removed, altered, defaced, or rendered illegible.



### How to Obtain Warranty Services

If, after following all of the operating instructions in this manual and checking the section "Before Calling Service Personnel," you find that service is needed:

- (1) For instructions on how to obtain warranty service for your DAV Product under the TACP DAV Product Warranty Exchange Program, contact TACP's Consumer Solutions Center toll free at 1 800 631 3811.
- (2) You must include the original bill of sale (or a copy of the original bill of sale) or other proof of purchase along with the entire DAV Product when sending the DAV Product to the TACP Warranty Exchange Center specified by TACP's Consumer Solutions Center. You are responsible for all inbound transportation and insurance charges for the DAV Product to the TACP Warranty Exchange Center.

For additional information, visit TACP's website:  
[www.tacp.toshiba.com](http://www.tacp.toshiba.com)

**ALL WARRANTIES IMPLIED BY THE LAW OF ANY STATE OF THE U.S.A., INCLUDING THE IMPLIED WARRANTIES OF MERCHANTABILITY AND FITNESS FOR A PARTICULAR PURPOSE, ARE EXPRESSLY LIMITED TO THE DURATION OF THE LIMITED WARRANTIES SET FORTH ABOVE. WITH THE EXCEPTION OF ANY WARRANTIES IMPLIED BY THE LAW OF ANY STATE OF THE U.S.A. AS HEREBY LIMITED, THE FOREGOING WARRANTY IS EXCLUSIVE AND IN LIEU OF ALL OTHER WARRANTIES, GUARANTEES, AGREEMENTS, AND OF ALL OTHER WARRANTIES, GUARANTEES, AGREEMENTS, AND OR REPLACEMENT OF ANY PARTS. IN NO EVENT SHALL TACP BE LIABLE FOR CONSEQUENTIAL OR INCIDENTAL DAMAGES (INCLUDING, BUT NOT LIMITED TO, LOST PROFITS, BUSINESS INTERRUPTION, OR MODIFICATION OR ERASURE OF RECORDED DATA CAUSED BY USE, MISUSE OR INABILITY TO USE THIS DAV PRODUCT).**

No person, agent, distributor, dealer, or company is authorized to change, modify, or extend the terms of these warranties in any manner whatsoever. The time within which an action must be commenced to enforce any obligation of TACP arising under the warranty or under any statute or law of the United States or any state thereof is hereby limited to ninety (90) days from the date you discover, or should have discovered, the defect. This limitation does not apply to implied warranties arising under state law.

**THIS WARRANTY GIVES YOU SPECIFIC LEGAL RIGHTS AND YOU MAY ALSO HAVE OTHER RIGHTS WHICH MAY VARY FROM STATE TO STATE IN THE U.S.A. SOME STATES OF THE U.S.A. DO NOT ALLOW LIMITATIONS ON HOW LONG AN IMPLIED WARRANTY LASTS, WHEN AN ACTION MAY BE BROUGHT, OR THE EXCLUSION OR LIMITATION OF INCIDENTAL OR CONSEQUENTIAL DAMAGES, SO THE ABOVE PROVISIONS MAY NOT APPLY TO YOU UNDER SUCH CIRCUMSTANCES.**

Others

## Limited Canadian Warranty For Toshiba Brand DVD Players, DVD Recorders, DVD/VCR Combo Players and Portable DVD Players

Toshiba of Canada Limited ("TCL") makes the following limited warranties to original consumers in Canada.

**THESE LIMITED WARRANTIES EXTEND TO THE ORIGINAL CONSUMER PURCHASER OR ANY PERSON RECEIVING THIS TOSHIBA BRAND DVD PLAYER, DVD RECORDER, DVD/VCR COMBO PLAYER OR PORTABLE DVD PLAYER (the "PLAYER(S)" or "Player(s)") AS A GIFT FROM THE ORIGINAL CONSUMER PURCHASER AND TO NO OTHER PURCHASER OR TRANSFEREE.**

**PLAYERS PURCHASED IN CANADA, AND USED ANYWHERE OUTSIDE OF CANADA INCLUDING, WITHOUT LIMITATION, THE UNITED STATES AND MEXICO, ARE NOT COVERED BY THESE WARRANTIES.**

**PLAYERS PURCHASED ANYWHERE OUTSIDE OF CANADA, INCLUDING, WITHOUT LIMITATION, THE UNITED STATES AND MEXICO, AND USED IN CANADA, ARE NOT COVERED BY THESE WARRANTIES.**

### Limited One (1) Year Warranty on Parts and Labour (home/non-commercial use)

Subject to the more limited warranty if the Player is used for any commercial or business purposes as set out below, TCL warrants the Player and its parts against material defects in materials or workmanship that result in the Player failing for a period of one (1) year after the date of original retail purchase. **DURING THIS PERIOD, TCL WILL, AT TCL'S OPTION, REPAIR OR REPLACE A DEFECTIVE PART WITH A NEW OR REFURBISHED PART, WITHOUT CHARGE TO YOU FOR PARTS OR LABOUR. YOU MUST DELIVER THE ENTIRE PLAYER TO THE CLOSEST TCL DESIGNATED DVD PLAYER, DVD RECORDER, DVD/VCR COMBO PLAYER OR PORTABLE DVD PLAYER AUTHORIZED SERVICE DEPOT ("ASD"). YOU MUST PAY FOR ALL TRANSPORTATION AND INSURANCE CHARGES FOR THE PLAYER TO AND FROM THE ASD.**

### Rental Units

The warranty for Player rental units begins with the date of first rental or thirty (30) days from the date of shipment to the rental firm, whichever comes first.

### Limited Warranty for Commercial Units

TCL warrants Players that are used for any commercial or business purposes as follows: all parts are warranted against material defects in materials or workmanship that result in the Player failing for a period of ninety (90) days after the date of original retail purchase. **DURING THIS PERIOD, TCL WILL, AT TCL'S OPTION, REPAIR OR REPLACE A DEFECTIVE PART WITH A NEW OR REFURBISHED PART, WITHOUT CHARGE TO YOU FOR PARTS OR LABOUR. YOU MUST DELIVER THE ENTIRE PLAYER TO THE CLOSEST ASD. YOU MUST PAY FOR ALL TRANSPORTATION AND INSURANCE CHARGES FOR THE PLAYER TO AND FROM THE ASD.**

### Your Responsibility

**THE ABOVE WARRANTIES ARE SUBJECT TO THE FOLLOWING CONDITIONS:**

- (1) You must provide your bill of sale or other proof of purchase.
- (2) All warranty servicing of this Player must be performed by a Toshiba Factory Service Depot.
- (3) The warranties from TCL are effective only if the Player is (i) purchased as new and unopened

from TCL or from TCL's authorized distributors, dealers or resellers ("ADR's") and (ii) located/operated in Canada.

- (4) Warranties extend only to material defects in materials or workmanship as limited above, and do not extend to:
  - a. Service, repairs or replacement made necessary by accident, misuse, abuse, moisture, liquids, dust, dirt, neglect, accident, damage, 24/7 applications, improper installation, improper operation, improper cleaning, improper maintenance, normal wear and tear, or any other external cause or event, act or omission outside the control of TCL, including fire, theft, acts of God, alteration, power failures, power surges or power shortages, lightning, other electrical faults, or repairs, modifications or replacements by persons other than those authorized by TCL to service the Player;
  - b. Replacement of missing, discarded or lost parts, the provision of retrofits, or preventive maintenance;
  - c. Repair of damage that is cosmetic only or does not affect the Player functionality, such as wear and tear, scratches and dents;
  - d. Service on Toshiba branded accessory items (such accessory items may be covered by their own warranty);
  - e. Service on third party products or service made necessary by use of incompatible third party products;
  - f. Service made necessary by the simultaneous use of this Player and connected equipment;
  - g. Modifications to the Player not approved in writing by TCL, and service made necessary by the use or installation of non Toshiba modifications to the Player;
  - h. Service of a Player on which the TOSHIBA label or logo, rating label or serial number have been defaced or removed;
    - i. On site service and repair of the Player;
    - j. Damage to the Player caused by failure to follow the specifications, User manuals or guides as to usage and/or storage.

### Disclaimer and Limitation of Remedy

**TO THE EXTENT NOT PRECLUDED BY LAW, ALL OTHER EXPRESS AND IMPLIED WARRANTIES, CONDITIONS AND REPRESENTATIONS FOR THIS PLAYER, INCLUDING THE IMPLIED WARRANTIES AND CONDITIONS OF MERCHANTABILITY AND FITNESS FOR A PARTICULAR PURPOSE, ARE HEREBY DISCLAIMED AND EXCLUDED. IF THE APPLICABLE LAW, STATUTORY OR OTHERWISE, PRECLUDES THE EXCLUSION OF ANY IMPLIED WARRANTIES, CONDITIONS AND REPRESENTATIONS THEN SUCH IMPLIED WARRANTIES, CONDITIONS AND REPRESENTATIONS ARE OTHERWISE LIMITED IN DURATION TO THE TERM OF THIS EXPRESS WRITTEN LIMITED WARRANTY. TO THE EXTENT NOT PRECLUDED BY LAW, THIS WRITTEN WARRANTY SUPERCEDES AND SPECIFICALLY DISCLAIMS ANY OTHER WARRANTY, CONDITION OR REPRESENTATION NOT STATED IN THIS WARRANTY, WHETHER MADE BY TCL, TOSHIBA CORPORATION, THEIR AFFILIATES, ADRs AND ASDs AND WHETHER MADE ORALLY OR IN WRITING (INCLUDING ANY STATEMENT IN ANY BROCHURE, PRESS RELEASE, ANNOUNCEMENT, ADVERTISEMENT, POINT OF SALE DISPLAY, ETC.).**

YOU MUST READ AND FOLLOW ALL SET-UP AND USAGE INSTRUCTIONS IN THE APPLICABLE USER GUIDES AND/OR MANUALS. IF YOU FAIL TO DO SO, THIS PLAYER MAY NOT FUNCTION PROPERLY AND YOU MAY SUFFER DAMAGE. THIS WARRANTY WILL NOT COVER ANY SERVICE THAT IS REQUIRED, IN PART OR IN WHOLE, AS A RESULT OF ANY FAILURE TO FOLLOW THE SET-UP AND USAGE INSTRUCTIONS. THIS WARRANTY DOES NOT APPLY AND SHALL BE VOID AND UNENFORCEABLE IF THE PLAYER IS OPENED, SERVICED, OR REPAIRED BY PERSONS OTHER THAN THOSE AUTHORIZED BY TCL TO SERVICE OR REPAIR THE PLAYER.

IF THE PLAYER FAILS TO WORK AS WARRANTED ABOVE, YOUR SOLE AND EXCLUSIVE REMEDY SHALL BE REPAIR OR REPLACEMENT OF THE DEFECTIVE PART. IN NO EVENT WILL TCL, TOSHIBA CORPORATION, THEIR AFFILIATES, ADRs OR ASDs (THE "RELATED PARTIES") BE LIABLE TO YOU OR ANY THIRD PARTY FOR ANY DAMAGES, MONEY, REIMBURSEMENT, COSTS OR EXPENSES. THIS LIMITATION APPLIES TO DAMAGES, MONEY, REIMBURSEMENT, COSTS OR EXPENSES OF ANY KIND WHATSOEVER INCLUDING ANY DIRECT OR INDIRECT DAMAGES, DAMAGE TO PROPERTY OR PERSON, LOST PROFITS, LOST SAVINGS, INCONVENIENCE OR OTHER SPECIAL, INCIDENTAL, EXEMPLARY OR CONSEQUENTIAL DAMAGES, WHETHER FOR BREACH OF WARRANTY, BREACH OF CONTRACT, TORT (INCLUDING NEGLIGENCE), UNDER A STATUTE OR UNDER ANY OTHER LAW OR FORM OR ACTION, OR WHETHER ARISING OUT OF THE USE OF OR INABILITY TO USE THE PLAYER, EVEN IF ANY OF THE RELATED PARTIES HAS BEEN ADVISED OF THE POSSIBILITY OF SUCH DAMAGES OR OF ANY CLAIM BY ANY OTHER PARTY.

No person, agent, distributor, dealer or company is authorized to change, modify or extend the terms of these warranties in any manner whatsoever.

#### Arbitration and Dispute Resolution

To the extent not precluded by law, any claim, dispute, controversy or disagreement (whether for breach of warranty, breach of contract, tort (including negligence), under a statute or under any other law or form of action) against any of the Related Parties arising out of, or otherwise relating to: (i) this warranty; (ii) the Player; (iii) any oral or written representations, statements, brochures, press releases, advertising, announcement, point of sale display, or promotional material relating to the Player; (iv) the relationships that result from this warranty, (the foregoing claims, disputes controversies and disagreements are collectively referred to as the "Dispute"), shall be referred to and resolved by final and binding arbitration (to the exclusion of the courts). To the extent not precluded by law, you agree to waive any right that you may have to commence or participate in any representative or class proceeding against the Related Parties relating to any Dispute. If and where applicable and to the extent not precluded by law, you further agree to opt out of any such representative or class proceedings. Arbitration of any Dispute will be conducted in the forum and in the manner as agreed to between you and TCL. Failing such agreement, the arbitration will be conducted by one arbitrator pursuant to the laws and rules relating to arbitration generally in force in the jurisdiction in which you reside at the time that the Dispute arises. To the extent not precluded by law, no claim, dispute,

controversy or disagreement of any other person may be joined or combined with any Dispute by you, without the prior written consent of TCL.

#### Critical Applications

The Player you have purchased is not designed for any "critical applications." "Critical applications" means life support systems, medical applications, connections to implanted medical devices, commercial transportation, nuclear facilities or systems or any other applications where Player failure could lead to injury to persons or loss of life or catastrophic property damage.

IF THE CUSTOMER USES THE PLAYER IN ANY CRITICAL APPLICATION, THE CUSTOMER – AND NOT TCL, ITS AFFILIATES, ADRs OR ASDs – ASSUME SOLE AND FULL RESPONSIBILITY FOR SUCH USE. TCL RESERVES THE RIGHT TO REFUSE TO SERVICE ANY PLAYER USED IN A CRITICAL APPLICATION. TCL, ITS AFFILIATES, ADRs AND ASDs HEREBY DISCLAIM ANY AND ALL LIABILITY, DAMAGES AND CONSEQUENCES ARISING OUT OF THE SERVICE OR REFUSAL TO SERVICE SUCH PLAYER AND FURTHER DISCLAIM ANY AND ALL LIABILITY, CONSEQUENCES AND DAMAGES THAT MAY ARISE OR RESULT FROM THE USE OF THE PLAYER IN ANY CRITICAL APPLICATIONS.

#### General Provisions

If and to the extent that any provision of this limited warranty should generally be found to be unenforceable, the unenforceable provision shall be severed from the warranty and deemed not to form part of the warranty. The remaining provisions of this warranty shall be and remain valid and enforceable. If and to the extent that any provision of this limited warranty as it relates to any of the Related Parties is found to be invalid or unenforceable in respect of that party (the "Excluded Party"), the Excluded Party shall be deemed to be severed or excluded from the provision, and the provision shall remain valid, enforceable and applicable in respect of the other or remaining Related Parties.

To the extent permitted by law, this limited warranty shall be governed and construed in accordance with the laws of Ontario.

If there is any inconsistency between this limited warranty, on the one hand, and any statement in the packaging of the Player or in any other document enclosed with, or used in the context of the promotion or sale of, the Player, on the other hand, the provisions of this limited warranty shall prevail.

#### How to Obtain Warranty Services

If, after following all of the operating instructions in this manual and checking the "Before Calling Service Personnel" section, you find that service is needed:

- (1) To find the nearest TCL Authorized Service Depot, visit TCL's web site at [www.toshiba.ca](http://www.toshiba.ca), or call toll free 1-866-275-6372.
- (2) Present your bill of sale or other proof of purchase to the Toshiba Factory Service Depot.

For additional information, visit TCL's website: [www.toshiba.ca](http://www.toshiba.ca)

**TOSHIBA**



Printed in China  
TSDAC10049A